

30" Induction Slide-in Range

800 Series – Stainless Steel HII8055U



BOSCH
Invented for life



HII8055U
Stainless Steel

The full-depth induction slide-in range allows fast & efficient cooking and has an oven that provides even baking on three racks.

Features & Benefits

Innovative induction technology offers fast, precise & efficient cooking.

Induction cooktop offers faster cooking results than gas or electric.

The warming drawer keeps your meals warm and ready to serve.

SpeedBoost® boils water 2x as fast as conventional electric ranges.

Genuine European convection for even baking results on multiple racks.

General Properties

Cooking modes	Bake, Variable Broil (hi & low), Roast, Warm, Proof Dough, Convection Bake, Convection Broil, Convection Roast, Multi-Rack Genuine European Convection, Convection Conversion, Pizza, Temperature Probe, Fast Preheat, Sabbath
---------------	--

Cleaning type	Self clean
Interior light	1
Kitchen timer	Yes
Drawer type	Warming drawer

Oven Performance

Bake / broil element watts (W)	2,400 / 3,800 W
Convection element watts (W)	2,000 W

Element Performance

Total cooktop elements	4
Power of front left element watts (W)	2,200 W (3,300 w/ boost)
Power of back left element watts (W)	1,400 W (1,800 w/ boost)
Power of back right element watts (W)	2,400 W (3,600 w/ boost)
Power of front right element watts (W)	1,400 W (1,800 w/ boost)

Element Size

Dimension of front left heating element	9"
Dimension of back left heating element	6"
Dimension of back right heating element	11"
Dimension of front right heating element	6"

Technical Details

Watts (W)	11,700 / 14,000 W
Circuit breaker (A)	40 A
Volts (V); Frequency (Hz)	208 V / 240 V; 60 Hz
Plug type	N/A
Energy source	Electric

Dimensions & Weight

Overall appliance dimensions (HxWxD)(in.)	35 1/2"-37" x 31 1/2" x 28 7/8"
Required cutout size (HxWxD)(in.)	35 1/2"-37" x 30" x 25"
Adjustable range height (in.)	1 1/2"
Oven cavity size (cu. ft.)	4.6
Overall oven interior dimensions (HxWxD)(in.)	17 13/16" x 24 1/8" x 18"
Usable oven interior dimensions (HxWxD)(in.)	12 5/16" x 23 1/4" x 15 1/4"
Net weight (lbs)	248 lbs

Accessories—Included

Use and care manual, installation guide, temperature probe, 3 standard racks

Accessories—Optional



HEZTR301
30" Telescopic rack



HEZBS301
4" Low backguard



HEZ390210
8" AutoChef® pan for 6" element



HEZ390220
9" AutoChef® pan for 7" element



HEZ390230
10" AutoChef® pan for 8" and 9" elements



For help and assistance with Bosch accessories please visit: www.bosch-eshop.com/eshop/bosch/us or call 1-800-944-2904 Mon-Fri 5am to 6pm PST Sat 6am to 3pm PST

Notes: All height, width and depth dimensions are shown in inches. BSH reserves the absolute and unrestricted right to change product materials and specifications, at any time, without notice. Consult the product's installation instructions for final dimensional data and other details prior to making cutout. Applicable product warranty can be found in accompanying product literature or you may contact your account manager for further details.

Warranties: Bosch warrants that the Product is free from defects in materials and workmanship for a period of three hundred and sixty-five (365) days from the date of purchase. The foregoing timeline begins to run upon the date of purchase, and shall not be stalled, tolled, extended, or suspended, for any reason whatsoever. This Product is also warranted to be free from cosmetic defects in material and workmanship (such as scratches of stainless steel, paint/porcelain blemishes, chip, dents, or other damage) to the finish of the Product, for a period of thirty (30) days from the date of purchase or closing date for new construction. This cosmetic warranty excludes slight color variations due to inherent differences in painted and porcelain parts, as well as differences caused by kitchen lighting, product location, or other similar factors. This cosmetic warranty specifically excludes any display, floor, "As Is", or "B" stock appliances.

For more information on our entire line of products, go to www.bosch-home.com/us or call 1-800-944-2904

© BSH Home Appliances Corporation. All rights reserved. Bosch is a registered trademark of Robert Bosch GmbH.

30" Induction Slide-in Range

800 Series – Stainless Steel HII8055U



BOSCH
Invented for life

Installation Details

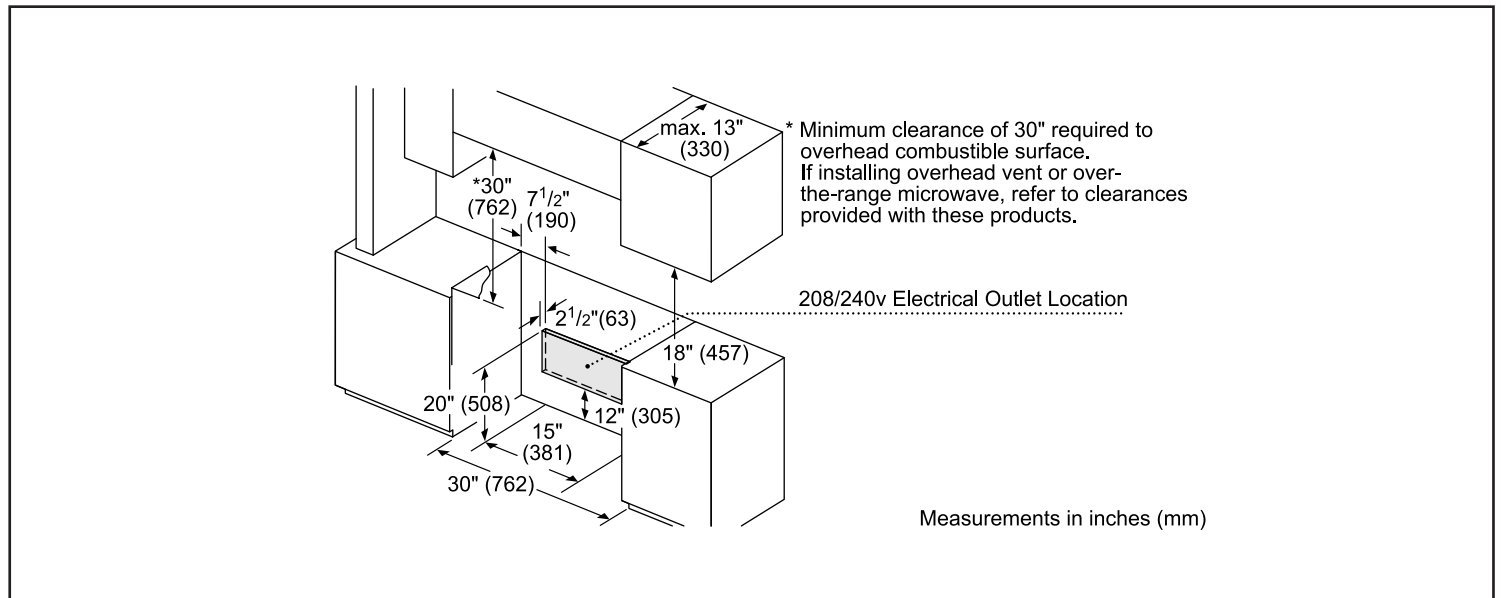
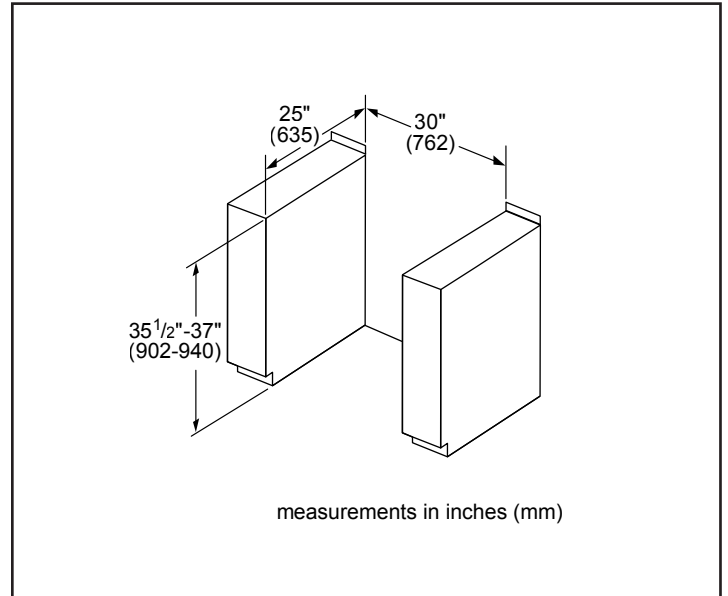
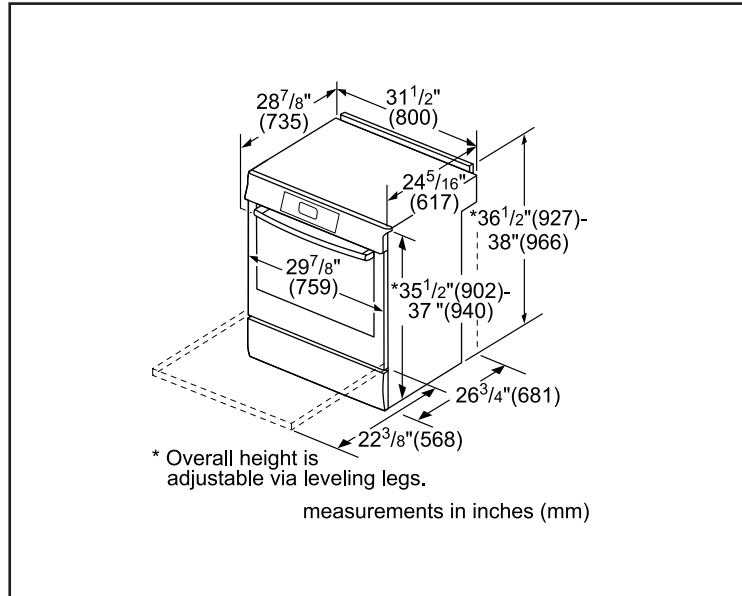

For help and assistance with Bosch accessories please visit: www.bosch-eshop.com/eshop/bosch/us or call 1-800-944-2904 Mon-Fri 5am to 6pm PST Sat 6am to 3pm PST

Notes: All height, width and depth dimensions are shown in inches. BSH reserves the absolute and unrestricted right to change product materials and specifications, at any time, without notice. Consult the product's installation instructions for final dimensional data and other details prior to making cutout. Applicable product warranty can be found in accompanying product literature or you may contact your account manager for further details.

Warranties: Bosch warrants that the Product is free from defects in materials and workmanship for a period of three hundred and sixty-five (365) days from the date of purchase. The foregoing timeline begins to run upon the date of purchase, and shall not be stalled, tolled, extended, or suspended, for any reason whatsoever. This Product is also warranted to be free from cosmetic defects in material and workmanship (such as scratches of stainless steel, paint/porcelain blemishes, chip, dents, or other damage) to the finish of the Product, for a period of thirty (30) days from the date of purchase or closing date for new construction. This cosmetic warranty excludes slight color variations due to inherent differences in painted and porcelain parts, as well as differences caused by kitchen lighting, product location, or other similar factors. This cosmetic warranty specifically excludes any display, floor, "As Is", or "B" stock appliances.

For more information on our entire line of products, go to www.bosch-home.com/us or call 1-800-944-2904

© BSH Home Appliances Corporation. All rights reserved. Bosch is a registered trademark of Robert Bosch GmbH.